

Project		Catalog #		Type	
Prepared by		Notes		Date	



# Streetworks

## GLAN Galleon II

Area / Site Luminaire

### Product Features



### Interactive Menu

- Ordering Information [page 2](#)
- Mounting Details [page 3](#)
- Optical Distributions [page 5](#)
- Product Specifications [page 5](#)
- Energy and Performance Data [page 6](#)
- Control Options [page 10](#)

### Product Certifications



### Quick Facts

- Lumen packages range from 3,300 - 73,500 (33W - 552W)
- 16 optical distributions
- Efficacy up to 159 lumens per watt
- Options to meet Buy American and other domestic preference requirements

### Connected Systems

- WaveLinx Lite
- WaveLinx

### Dimensional Details

#### Standard Arm

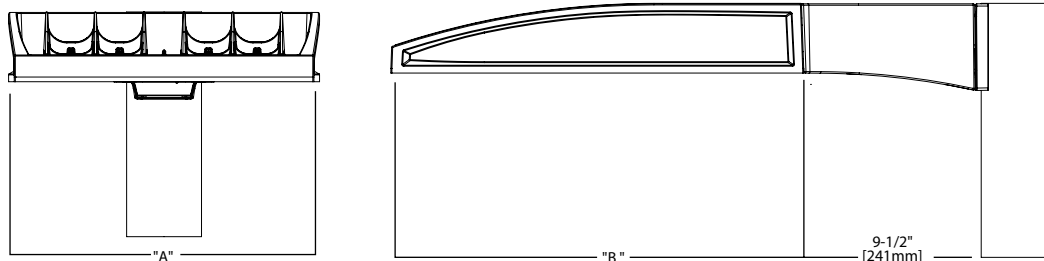

Number of Light Squares	Width "A"	Housing Length "B"	Weight with Standard or QM Arm	EPA with Standard or QM Arm
1-4	16"	22"	29 lb	0.95
5-6	22"	22"	39 lb	0.95
7-9	22"	28-1/8"	48 lb	1.1

**NOTES:**  
For arm selection requirements and additional line art, see Mounting Details section.

**NOTES:**  
1. Visit <https://www.designlights.org/search/> to confirm qualification. Not all product variations are DLC qualified.  
2. IDA Certified for 3000K CCT and warmer only.

### Pole Drilling Patterns Type "N"

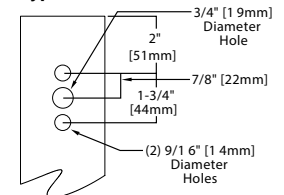

## Ordering Information

SAMPLE NUMBER: **GLAN-SA4C-740-U-T4FT-GM**

Product Family <sup>1,2</sup>	Light Engine		Color Temperature	Voltage	Distribution	Mounting	Finish
	Configuration	Drive Current					
<b>GLAN</b> =Galleon II <b>BAA-GLAN</b> = Galleon II Buy American Act Compliant <sup>30</sup> <b>TAA-GLAN</b> = Galleon II Trade Agreements Act Compliant <sup>30</sup>	<b>SA1</b> =1 Square <b>SA2</b> =2 Squares <b>SA3</b> =3 Squares <b>SA4</b> =4 Squares <b>SA5</b> =5 Squares <b>SA6</b> =6 Squares <b>SA7</b> =7 Squares <b>SA8</b> =8 Squares <b>SA9</b> =9 Squares	<b>A</b> =600mA <b>B</b> =800mA <b>C</b> =1000mA <b>D</b> =1200mA <sup>4,17</sup> <b>Z</b> =Configured <sup>33</sup>	<b>722</b> =70CRI, 2200K <b>727</b> =70CRI, 2700K <b>730</b> =70CRI, 3000K <b>735</b> =70CRI, 3500K <b>740</b> =70CRI, 4000K <b>750</b> =70CRI, 5000K <b>760</b> =70CRI, 6000K <b>827</b> =80CRI, 2700K <b>830</b> =80CRI, 3000K <b>AMB</b> =Amber, 590nm <sup>15,17</sup>	<b>U</b> =120-277V <b>H</b> =347V-480V <sup>7,29</sup> 1=120V 2=208V 3=240V 4=277V 8=480V <sup>7,29</sup> 9=347V <sup>7</sup> <b>DV</b> =277V-480V DuraVolt Drivers <sup>27,28,29</sup>	<b>T2</b> =Type II <b>T2R</b> =Type II Roadway <b>T3</b> =Type III <b>T3R</b> =Type III Roadway <b>T4FT</b> =Type IV Forward Throw <b>T4W</b> =Type IV Wide <b>5NQ</b> =Type V Narrow <b>5MQ</b> =Type V Square Medium <b>5WQ</b> =Type V Square Wide <b>SL2</b> =Type II w/Spill Control <b>SL3</b> =Type III w/Spill Control <b>SL4</b> =Type IV w/Spill Control <b>SLL</b> =90° Spill Light Eliminator Left <b>SLR</b> =90° Spill Light Eliminator Right <b>RW</b> =Rectangular Wide Type I <b>AFL</b> =Automotive Frontline	<b>[Blank]</b> =Standard Pole Mount Arm <b>QM</b> =Standard Pole Mount Arm with Quick Mount Adaptor <b>PA</b> =Pole Mount, Adjustable <b>SP</b> =Slipfitter, Adjustable <sup>8</sup> <b>MA</b> =Mast Arm, Fixed <b>WM</b> =Wall Mount, Fixed <b>WA</b> =Wall Mount, Adjustable <b>UP</b> =Upswept Arm	<b>AP</b> =Grey <b>BZ</b> =Bronze <b>BK</b> =Black <b>DP</b> =Dark Platinum <b>GM</b> =Graphite Metallic <b>WH</b> =White <b>RALXX</b> =Custom Color
Options (Add as Suffix)			Controls and Systems Options (Add as Suffix)			Accessories (Order Separately) <sup>31</sup>	
<b>DIM</b> =External 0-10V Dimming Leads <sup>20</sup> <b>F</b> =Single Fuse (120, 277 or 347V Specify Voltage) <b>FF</b> =Double Fuse (208, 240 or 480V Specify Voltage) <b>20K</b> =20KV UL 1449 fused surge protective device <sup>10</sup> <b>2L</b> =Two Circuits <sup>10</sup> <b>TB</b> =3-Position Terminal Block <b>HA</b> =50°C High Ambient <b>HSS</b> =Installed House Side Shield <sup>18</sup> <b>GRSBK</b> =Glare Reducing Shield, Black <sup>23</sup> <b>GRSWH</b> =Glare Reducing Shield, White <sup>23</sup> <b>LCF</b> =Light Square Trim Painted to Match Housing <sup>26</sup> <b>TH</b> =Tool-less Door Hardware <sup>5</sup> <b>CC</b> =Coastal Construction finish <sup>3</sup> <b>L90</b> =Optics Rotated 90° Left <b>R90</b> =Optics Rotated 90° Right <b>AHD145</b> =After Hours Dim, 5 Hours <sup>22</sup> <b>AHD245</b> =After Hours Dim, 6 Hours <sup>22</sup> <b>AHD255</b> =After Hours Dim, 7 Hours <sup>22</sup> <b>AHD355</b> =After Hours Dim, 8 Hours <sup>22</sup> <b>DALI</b> =DALI Drivers <b>DXXXXX</b> =Department of Transportation - Customer specific details <sup>33</sup> <b>UXXXXX</b> =Utility - Customer specific details <sup>33</sup>			<b>BPC</b> =Button Type Photocontrol <sup>4</sup> <b>PR</b> =NEMA 3-PIN Photocontrol Receptacle <b>PR7</b> =NEMA 7-PIN Photocontrol Receptacle <sup>21</sup> <b>FADC</b> =Field Adjustable Dimming Controller <sup>32</sup> <b>SPB2</b> =Dimming Motion Sensor, 9'-20' mounting <sup>24</sup> <b>SPB4</b> =Dimming Motion Sensor, 21'-40' mounting <sup>24</sup> <b>SPB2/X</b> =Dimming Motion Sensor, limited square count, 9'-20' mounting <sup>24</sup> <b>SPB4/X</b> =Dimming Motion Sensor, limited square count, 21'-40' mounting <sup>24</sup> <b>ZW</b> =WaveLinX-enabled 4-PIN Twistlock Receptacle <sup>19</sup> <b>ZD</b> =SR Driver-enabled 4-PIN Twistlock Receptacle <sup>19</sup> <b>ZW-WOBXX</b> =WaveLinX Lite, Dimming Motion and Daylight, Bluetooth Programmable, 7' - 15' Mounting <sup>19,12,13</sup> <b>ZW-WOFXX</b> =WaveLinX Lite, Dimming Motion and Daylight, Bluetooth Programmable, 15' - 40' Mounting <sup>19,12,13</sup> <b>ZD-WOBXX</b> =WaveLinX Lite, SR Driver, Dimming Motion and Daylight, Bluetooth Programmable, 7' - 15' Mounting <sup>19,12,13</sup> <b>ZD-WOFXX</b> =WaveLinX Lite, SR Driver, Dimming Motion and Daylight, Bluetooth Programmable, 15' - 40' Mounting <sup>19,12,13</sup> <b>ZW-SWPD4XX</b> =WaveLinX Pro, Dimming Motion and Daylight, WAC Programmable, 7' - 15' Mounting <sup>19,12,13</sup> <b>ZW-SWPD5XX</b> =WaveLinX Pro, Dimming Motion and Daylight, WAC Programmable, 15' - 40' Mounting <sup>19,12,13</sup> <b>ZD-SWPD4XX</b> =WaveLinX Pro, SR Driver, Dimming Motion and Daylight, WAC Programmable, 7' - 15' Mounting <sup>19,12,13</sup> <b>ZD-SWPD5XX</b> =WaveLinX Pro, SR Driver, Dimming Motion and Daylight, WAC Programmable, 15' - 40' Mounting <sup>19,12,13</sup> <b>DIM10-L20</b> =Synapse Occupancy Sensor (9'-20' Mounting) <sup>19</sup> <b>DIM10-L40</b> =Synapse Occupancy Sensor (21'-40' Mounting) <sup>19</sup>			<b>OA/RA1016</b> =NEMA Photocontrol Multi-Tap - 105-285V <b>OA/RA1027</b> =NEMA Photocontrol - 480V <b>OA/RA1201</b> =NEMA Photocontrol - 347V <b>OA/RA1013</b> =Photocontrol Shorting Cap <b>OA/RA1014</b> =120V Photocontrol <b>MA1252</b> =10kV Surge Module Replacement <b>MA1036-XX</b> =Single Tenon Adapter for 2-3/8" O.D. Tenon <b>MA1037-XX</b> =2@180° Tenon Adapter for 2-3/8" O.D. Tenon <b>MA1197-XX</b> =3@120° Tenon Adapter for 2-3/8" O.D. Tenon <b>MA1188-XX</b> =4@90° Tenon Adapter for 2-3/8" O.D. Tenon <b>MA1189-XX</b> =2@90° Tenon Adapter for 2-3/8" O.D. Tenon <b>MA1190-XX</b> =3@90° Tenon Adapter for 2-3/8" O.D. Tenon <b>MA1191-XX</b> =2@120° Tenon Adapter for 2-3/8" O.D. Tenon <b>MA1038-XX</b> =Single Tenon Adapter for 3-1/2" O.D. Tenon <b>MA1039-XX</b> =2@180° Tenon Adapter for 3-1/2" O.D. Tenon <b>MA1192-XX</b> =3@120° Tenon Adapter for 3-1/2" O.D. Tenon <b>MA1193-XX</b> =4@90° Tenon Adapter for 3-1/2" O.D. Tenon <b>MA1194-XX</b> =2@90° Tenon Adapter for 3-1/2" O.D. Tenon <b>MA1195-XX</b> =3@90° Tenon Adapter for 3-1/2" O.D. Tenon <b>SRA238</b> =Adapter kit for mounting to 2-3/8" O.D. Tenon <b>LS/HSS</b> =Field Installed House Side Shield <sup>9,18</sup> <b>LS/GRSBK-2PK</b> =Glare Reducing Shield, Black <sup>9,23</sup> <b>LS/GRSWH-2PK</b> =Glare Reducing Shield, White <sup>9,23</sup> <b>LS/PFS</b> =Perimeter Shield, Black <sup>16</sup> <b>WOLC-7P-10A</b> =WaveLinX Outdoor Control Module <sup>11,19</sup> <b>WOB-XX</b> =WaveLinX Lite Sensor, Dimming Motion and Daylight, Bluetooth Programmable, 7' - 15' Mounting <sup>12,13,14,19</sup> <b>WOF-XX</b> =WaveLinX Lite Sensor, Dimming Motion and Daylight, Bluetooth Programmable, 15' - 40' Mounting <sup>12,13,14,19</sup> <b>SWPD4-XX</b> =WaveLinX Sensor, Dimming Motion and Daylight, WAC Programmable, 7' - 15' Mounting <sup>12,13,14,19</sup> <b>SWPD5-XX</b> =WaveLinX Sensor, Dimming Motion and Daylight, WAC Programmable, 15' - 40' Mounting <sup>12,13,14,19</sup>	
<b>NOTES:</b> 1. Customer is responsible for engineering analysis to confirm pole and fixture compatibility for all applications. Refer to our white paper WPS13001EN for additional support information. 2. DesignLights Consortium® Qualified. Refer to <a href="http://www.designlights.org">www.designlights.org</a> Qualified Products List under Family Models for details. 3. Coastal construction finish salt spray tested to over 5,000-hours per ASTM B117, with a scribe rating of 9 per ASTM D1654. Not available with TH option. 4. Drive current 1200mA not available with color temperatures 722, 727 or 830 when either HA or HSS options are selected. 5. TH option not 3G rated. Not available with Coastal Construction (CC) option. 6. Not available with voltage options H, 8 or 9. 7. Requires the use of an internal step down transformer when combined with sensor options. Not available in combination with the HA high ambient and sensor options at 1A. 8. Adjustable Slipfitter arm limited to vertical 3" tenon. For mounting to 2-3/8" O.D. tenons, order accessory SRA238. 9. One required for each Light Square. 10. 2L is not available with SPB at 347V or 480V. Not available with WaveLinX or Enlighted sensors, or 20kV surge option. 11. Requires PR7. 12. Replace XX with sensor color (WH, BZ or BK.) 13. WAC Gateway required to enable field-configurability: Order WAC-PoE and WPOE-120 (10V to PoE injector) power supply if needed. WAC not required for LC Bluetooth sensors. 14. Requires ZW or ZD receptacle. 15. Narrow-band 590nm +/- 5nm for wildlife and observatory use. Choose drive current A; supplied at 500mA drive current only. Exact luminaire wattage available in IES files. Available with 5WQ, 5MQ, SL2, SL3 and SL4 distributions. Can be used with HSS option. 16. Set of 4 pcs. One set required per Light Square. 17. Not available with HA option. 18. Not for use with 5NQ, 5MQ, 5WQ or RW optics. A black trim plate is used when HSS is selected. 19. Cannot be used with other control options. 20. Low voltage control lead brought out 18" outside fixture. Not available with DALI or integrated controls options 21. Not available if any SPB, LWR, or WaveLinX sensor is selected. Motion sensor has an integral photocell. 22. Requires the use of BPC photocontrol or the PR7 or PR photocontrol receptacle with photocontrol accessory. 23. Not for use with T4FT, T4W or SL4 optics. See IES files for details. 24. Sensor configuration mobile application required for configuration. See controls page for details. 25. Replace X with number of Light Squares controlled by the SPB, referencing the "SPB/X Availability Table" on the controls page. 26. Not available with HSS, GRSWH or GRSBK. 27. DuraVolt drivers feature added protection from power quality issues such as loss of neutral, transients and voltage fluctuations. Visit <a href="http://www.signify.com/duravolt">www.signify.com/duravolt</a> for more information. 28. Not available in 1 square configuration at 800mA and below. Not available with any control option except SPB. 29. 480V not to be used with ungrounded or impedance grounded systems. 30. Only product configurations with these designated prefixes are built to be compliant with the Buy American Act of 1933 (BAA) or Trade Agreements Act of 1979 (TAA), respectively. Please refer to <a href="http://DOMESTIC.PREFERENCES">DOMESTIC.PREFERENCES</a> website for more information. Components shipped separately may be separately analyzed under domestic preference requirements. 31. Accessories sold separately will be separately analyzed under domestic preference requirements. Consult factory for further information. 32. Cannot be used with PR7 or other motion response control options. 33. Customer specific specifications utilizes standard products with small adjustments to meet unique requirements such as packaging, labels, wattage adjustments, etc. Use GALN Product Configurator to specify lumen output, drive current and wattage. Not available with AMB.							

## LumenSafe Integrated Network Security Camera Technology Options (Add as Suffix)

Product Family	Camera Type	Data Backhaul
<b>L</b> =LumenSafe Technology 	<b>D</b> =Standard Dome Camera <b>H</b> =Hi-Res Dome Camera <b>Z</b> =Remote PTZ Camera	<b>C</b> =Cellular, No SIM <b>A</b> =Cellular, AT&T <b>V</b> =Cellular, Verizon <b>S</b> =Cellular, Sprint <b>R</b> =Cellular, Rogers <b>W</b> =Wi-Fi Networking w/ Omni-Directional Antenna <b>E</b> =Ethernet Networking

## Mounting Details

### Pole Configuration Options

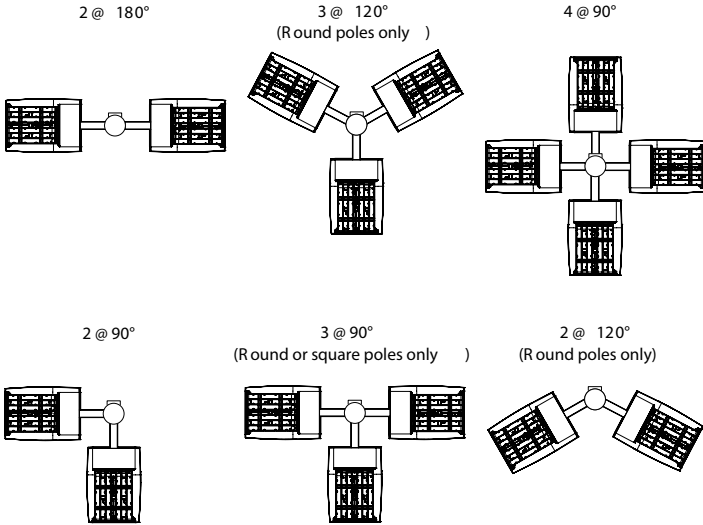

### Quick Mount Arm (QM) \*

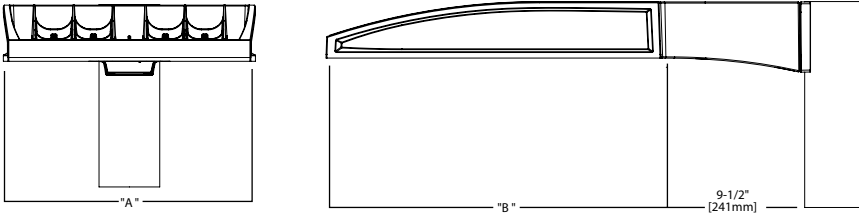

\*NOTE: Use Type N drilling pattern

### Upswept Arm (UP) \*

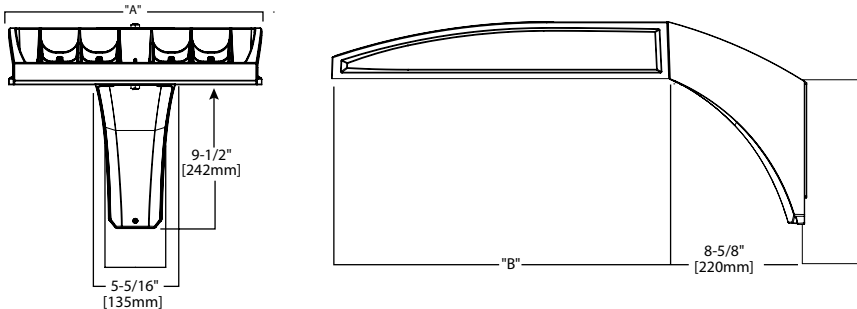

\*NOTE: Use Type N, R or M drilling pattern

### Mast Arm, Fixed (MA)

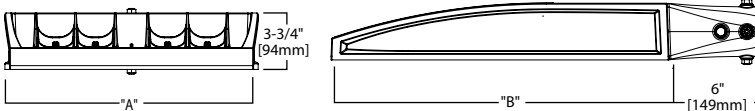

### Wall Mount, Fixed (WM)

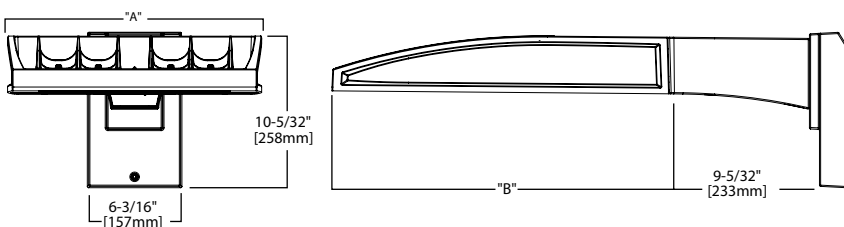

### Pole Drilling Patterns

#### Type "N"

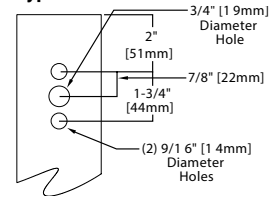

#### Type "N"

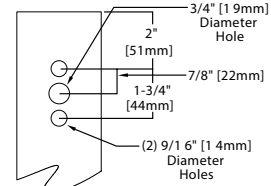

#### Type "R"

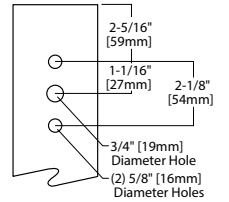

#### Type "M"

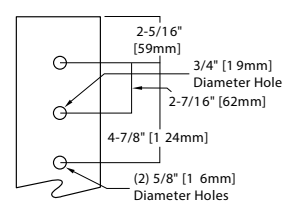

## Mounting Details

### Wall Mount, Adjustable (WA)

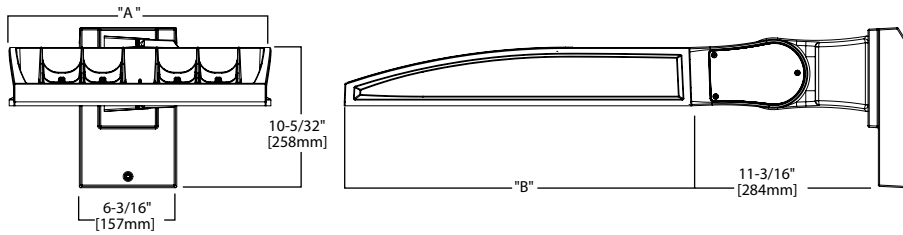

### Slipfitter, Adjustable (SP)

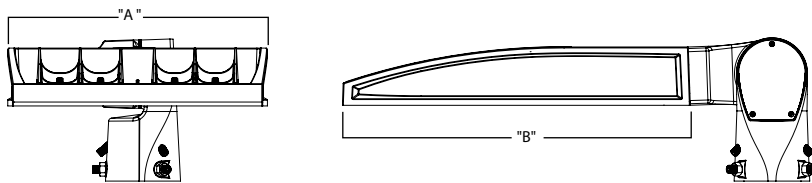

### Pole Mount, Adjustable Arm (PA)

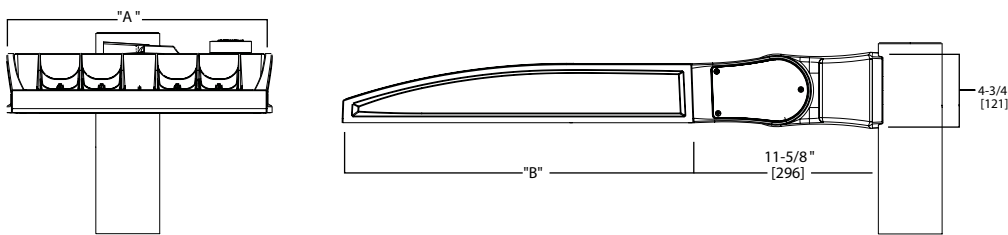

### Adjustable Arm Range of Motion

- Wall Mount (WA), Slipfitter (SP) and Pole Mount (PA)
- Adjustable in increments of 5°
- Must maintain downward facing orientation

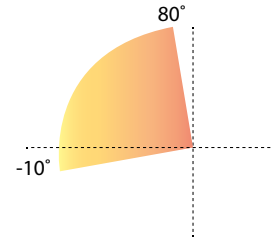

### Fixture Weights and EPAs

Tilt Angle (Degrees)	Number of Light Squares	Weight	1 @ 90°	2 @ 180°	2 @ 90°	2 @ 120°	3 @ 90°	3 @ 120°	4 @ 90°
0°	1-4	33.5 lb (15.2 kg)	0.85	1.70	1.46	1.66	2.31	2.25	2.35
	5-6	43.5 lb (19.7 kg)	0.86	1.71	1.62	1.80	2.49	2.35	2.50
	7-9	52.5 lb (23.8 kg)	0.98	1.95	1.75	1.98	2.73	2.55	2.76
15°	1-4	33.5 lb (15.2 kg)	1.10	1.71	1.95	2.26	2.81	3.30	2.87
	5-6	43.5 lb (19.7 kg)	1.42	1.71	2.27	2.72	3.13	3.63	3.15
	7-9	52.5 lb (23.8 kg)	1.69	1.96	2.67	3.22	3.65	4.38	3.72
30°	1-4	33.5 lb (15.2 kg)	1.72	1.81	2.58	3.21	3.44	4.59	3.53
	5-6	43.5 lb (19.7 kg)	2.26	2.29	3.11	4.00	3.97	5.27	4.00
	7-9	52.5 lb (23.8 kg)	2.75	2.85	3.73	4.83	4.71	6.45	4.81
45°	1-4	33.5 lb (15.2 kg)	2.25	2.36	3.10	4.00	3.96	5.63	4.08
	5-6	43.5 lb (19.7 kg)	2.96	2.99	3.81	5.06	4.67	6.49	4.71
	7-9	52.5 lb (23.8 kg)	3.63	3.76	3.73	6.17	5.59	8.03	5.73
60°	1-4	33.5 lb (15.2 kg)	2.63	2.77	3.49	4.58	4.34	6.21	4.48
	5-6	43.5 lb (19.7 kg)	3.46	3.51	4.32	5.84	5.19	7.01	5.22
	7-9	52.5 lb (23.8 kg)	4.27	4.44	5.25	7.15	6.23	8.80	6.40

## Optical Distributions

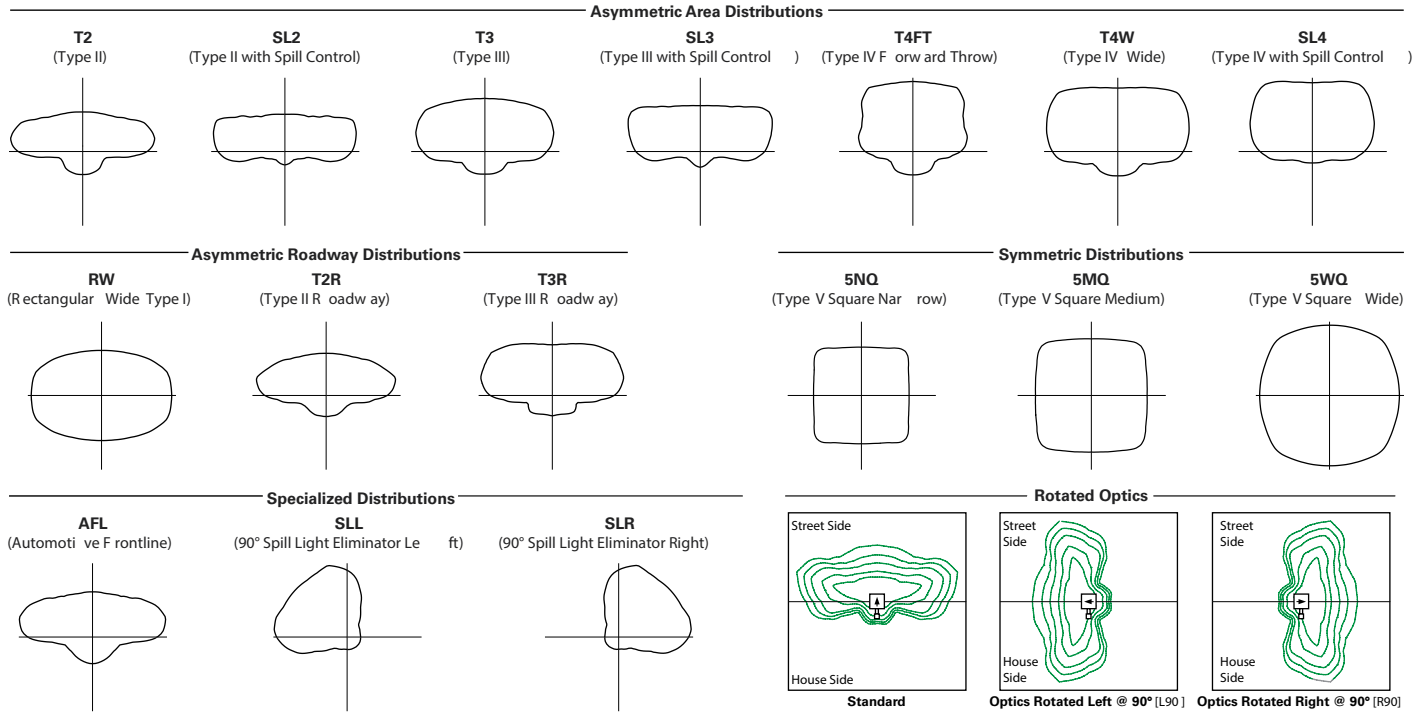

## Product Specifications

### Construction

- Die-cast aluminum housing and heat sink
- Three housing sizes, using 1 to 9 light squares
- Driver compartment utilizes hinged door with captive fasteners

### Optics

- High-efficiency injection-molded AccuLED Optics technology
- 16 optical distributions for area site and roadway applications
- 3 shielding options include HSS, GRS and PFS
- IDA certified (3000K CCT and warmer only, arms at 0° tilt)

### Electrical

- Removable power tray assembly includes drivers, surge modules and control modules for ease of maintenance and serviceability
- Standard with 0-10V dimming
- Standard with 10kV surge module, optional 20kV surge module
- Suitable for operation in -40°C to 40°C ambient environments. Optional 50°C high ambient (HA) configuration

### Mounting

- Arms are factory installed, enabling closed-housing installation
- All arms suitable for round or square pole installation
- All arms provide clearance for multiple fixture installations at 90°

### Finish

- 6 standard finishes use super durable TGIC polyester powder coat paint, providing 2.5 mil nominal thickness and salt-spray tested to 3,000 hours per ASTM B117
- RAL and custom color matches available
- Coastal Construction (CC) option salt-spray tested to 5,000 hours per ASTM B117, achieving a scribe rating of 9 per ASTM D1654

### Warranty

- Five year limited warranty

## Energy and Performance Data

### Lumen Maintenance (TM-21)

Drive Current	Ambient Temperature	25,000 hours*	50,000 hours*	60,000 hours*	100,000 hours**	Theoretical L70 hours**
Up to 1A	25°C	99.4%	99.0%	98.9%	98.3%	> 2.4M
	40°C	98.7%	98.3%	98.1%	97.4%	> 1.9M
	50°C	98.2%	97.2%	96.8%	95.2%	> 851,000
1.2A	25°C	99.4%	99.0%	98.9%	98.3%	> 2.4M
	40°C	98.5%	97.9%	97.7%	96.7%	> 1.3M

### Lumen Multiplier

Ambient Temperature	Lumen Multiplier
0°C	1.02
10°C	1.01
25°C	1.00
40°C	0.99
50°C	0.97

\* Supported by IES TM-21 standards

\*\* Theoretical values represent estimations commonly used; however, refer to the IES position on LED Product Lifetime Prediction, IES PS-10-18, explaining proper use of IES TM-21 and LM-80.

### FADC Settings

#### SA1-SA3 (A, B, C, D Drive Current)

FADC Position	Percent of Typical Lumen Output
1	25%
2	48%
3	56%
4	65%
5	75%
6	80%
7	85%
8	90%
9	95%
10	100%

### FADC Settings

#### SA4-SA6 (A, B, C, D Drive Current)

FADC Position	Percent of Typical Lumen Output
1	14%
2	25%
3	32%
4	43%
5	49%
6	57%
7	65%
8	72%
9	80%
10	100%

### FADC Settings

#### SA7-SA9 (A, B, C, D Drive Current)

FADC Position	Percent of Typical Lumen Output
1	19%
2	38%
3	47%
4	63%
5	74%
6	85%
7	95%
8	97%
9	100%
10	100%

Performance Table, Drive Current "A" (615mA)

Number of Light Squares		1	2	3	4	5	6	7	8	9
<b>Nominal Power (Watts)</b>		33	63	93	121	154	182	215	244	274
<b>Input Current @ 120V</b>		0.283	0.529	0.778	1.058	1.310	1.556	1.839	2.089	2.335
<b>Input Current @ 208V</b>		0.165	0.309	0.460	0.618	0.771	0.919	1.082	1.240	1.379
<b>Input Current @ 240V</b>		0.143	0.270	0.398	0.540	0.671	0.796	0.944	1.078	1.194
<b>Input Current @ 277V</b>		0.125	0.237	0.352	0.473	0.581	0.705	0.818	0.962	1.057
<b>Input Current @ 347V</b>		0.098	0.181	0.272	0.362	0.454	0.544	0.636	0.738	0.816
<b>Input Current @ 480V</b>		0.073	0.133	0.200	0.267	0.335	0.400	0.470	0.554	0.600
Optics										
<b>T2</b>	4000K Lumens	4,654	9,249	13,730	18,194	23,032	27,273	32,034	37,138	41,694
	BUG Rating	B1-U0-G1	B1-U0-G2	B2-U0-G2	B2-U0-G3	B3-U0-G4	B3-U0-G4	B3-U0-G4	B3-U0-G5	B3-U0-G5
	Lumens per Watt	141	147	148	150	150	150	149	152	152
<b>T2R</b>	4000K Lumens	4,716	9,372	13,913	18,437	23,340	27,637	32,462	37,634	42,251
	BUG Rating	B1-U0-G1	B1-U0-G2	B2-U0-G2	B2-U0-G2	B3-U0-G3	B3-U0-G3	B3-U0-G4	B3-U0-G4	B3-U0-G4
	Lumens per Watt	143	149	150	152	152	152	151	154	154
<b>T3</b>	4000K Lumens	4,589	9,120	13,538	17,940	22,711	26,892	31,587	36,620	41,112
	BUG Rating	B1-U0-G1	B2-U0-G2	B2-U0-G2	B3-U0-G3	B3-U0-G3	B3-U0-G4	B3-U0-G4	B3-U0-G4	B4-U0-G4
	Lumens per Watt	139	145	146	148	147	148	147	150	150
<b>T3R</b>	4000K Lumens	4,735	9,411	13,970	18,513	23,436	27,751	32,596	37,790	42,425
	BUG Rating	B1-U0-G1	B1-U0-G2	B2-U0-G3	B2-U0-G3	B3-U0-G4	B3-U0-G4	B3-U0-G4	B3-U0-G5	B3-U0-G5
	Lumens per Watt	143	149	150	153	152	152	152	155	155
<b>T4FT</b>	4000K Lumens	4,617	9,176	13,622	18,051	22,851	27,058	31,782	36,847	41,366
	BUG Rating	B1-U0-G2	B2-U0-G2	B2-U0-G3	B3-U0-G3	B3-U0-G4	B3-U0-G4	B3-U0-G5	B3-U0-G5	B3-U0-G5
	Lumens per Watt	140	146	146	149	148	149	148	151	151
<b>T4W</b>	4000K Lumens	4,631	9,203	13,662	18,104	22,918	27,138	31,876	36,955	41,488
	BUG Rating	B1-U0-G2	B2-U0-G2	B2-U0-G3	B3-U0-G3	B3-U0-G4	B3-U0-G4	B3-U0-G5	B3-U0-G5	B4-U0-G5
	Lumens per Watt	140	146	147	150	149	149	148	151	151
<b>SL2</b>	4000K Lumens	4,619	9,180	13,627	18,058	22,860	27,069	31,795	36,861	41,383
	BUG Rating	B1-U0-G2	B2-U0-G2	B2-U0-G3	B3-U0-G3	B3-U0-G4	B3-U0-G4	B3-U0-G4	B3-U0-G5	B4-U0-G5
	Lumens per Watt	140	146	147	149	148	149	148	151	151
<b>SL3</b>	4000K Lumens	4,586	9,115	13,531	17,931	22,699	26,879	31,571	36,602	41,091
	BUG Rating	B1-U0-G1	B1-U0-G2	B2-U0-G3	B2-U0-G3	B3-U0-G4	B3-U0-G4	B3-U0-G4	B3-U0-G5	B3-U0-G5
	Lumens per Watt	139	145	145	148	147	148	147	150	150
<b>SL4</b>	4000K Lumens	4,529	9,002	13,363	17,708	22,417	26,544	31,178	36,146	40,580
	BUG Rating	B1-U0-G2	B1-U0-G3	B2-U0-G3	B2-U0-G4	B2-U0-G4	B3-U0-G5	B3-U0-G5	B3-U0-G5	B3-U0-G5
	Lumens per Watt	137	143	144	146	146	146	145	148	148
<b>5NQ</b>	4000K Lumens	4,829	9,598	14,247	18,880	23,901	28,301	33,242	38,539	43,266
	BUG Rating	B2-U0-G1	B3-U0-G1	B3-U0-G2	B4-U0-G2	B4-U0-G2	B4-U0-G2	B5-U0-G2	B5-U0-G3	B5-U0-G3
	Lumens per Watt	146	152	153	156	155	155	155	158	158
<b>5MQ</b>	4000K Lumens	4,853	9,645	14,318	18,974	24,020	28,442	33,407	38,731	43,482
	BUG Rating	B3-U0-G1	B3-U0-G2	B4-U0-G2	B4-U0-G2	B5-U0-G3	B5-U0-G3	B5-U0-G4	B5-U0-G4	B5-U0-G4
	Lumens per Watt	147	153	154	157	156	156	155	159	159
<b>5WQ</b>	4000K Lumens	4,843	9,625	14,288	18,934	23,969	28,382	33,337	38,649	43,390
	BUG Rating	B3-U0-G1	B4-U0-G2	B4-U0-G2	B5-U0-G3	B5-U0-G3	B5-U0-G4	B5-U0-G4	B5-U0-G4	B5-U0-G5
	Lumens per Watt	147	153	154	156	156	156	155	158	158
<b>SLL/SLR</b>	4000K Lumens	3,989	7,927	11,768	15,594	19,741	23,375	27,456	31,831	35,736
	BUG Rating	B1-U0-G2	B1-U0-G2	B2-U0-G3	B2-U0-G3	B2-U0-G4	B3-U0-G4	B3-U0-G4	B3-U0-G5	B3-U0-G5
	Lumens per Watt	121	126	127	129	128	128	128	130	130
<b>RW</b>	4000K Lumens	4,774	9,488	14,085	18,665	23,628	27,979	32,863	38,100	42,774
	BUG Rating	B2-U0-G1	B3-U0-G1	B3-U0-G2	B4-U0-G2	B4-U0-G2	B4-U0-G2	B5-U0-G3	B5-U0-G3	B5-U0-G3
	Lumens per Watt	145	151	151	154	153	154	153	156	156
<b>AFL</b>	4000K Lumens	4,673	9,286	13,785	18,268	23,126	27,384	32,164	37,290	41,864
	BUG Rating	B1-U0-G1	B1-U0-G1	B2-U0-G2	B2-U0-G2	B3-U0-G2	B3-U0-G2	B3-U0-G3	B3-U0-G3	B3-U0-G3
	Lumens per Watt	142	147	148	151	150	150	150	153	153

\* Nominal data for 70 CRI. \*\* For additional performance data, please reference the Galleon Supplemental Performance Guide.

Performance Table, Drive Current "B" (800mA)

Number of Light Squares		1	2	3	4	5	6	7	8	9
<b>Nominal Power (Watts)</b>		44	82	121	164	204	243	286	325	364
<b>Input Current @ 120V</b>		0.367	0.689	1.014	1.378	1.704	2.027	2.393	2.716	3.041
<b>Input Current @ 208V</b>		0.213	0.401	0.594	0.802	0.997	1.188	1.400	1.605	1.782
<b>Input Current @ 240V</b>		0.184	0.347	0.510	0.694	0.860	1.021	1.210	1.386	1.531
<b>Input Current @ 277V</b>		0.160	0.303	0.449	0.605	0.757	0.898	1.065	1.242	1.347
<b>Input Current @ 347V</b>		0.125	0.235	0.355	0.471	0.592	0.710	0.828	0.958	1.065
<b>Input Current @ 480V</b>		0.092	0.172	0.258	0.344	0.432	0.517	0.605	0.706	0.775
Optics										
<b>T2</b>	4000K Lumens	5,790	11,508	17,083	22,638	28,658	33,935	39,859	46,210	51,879
	BUG Rating	B1-U0-G2	B2-U0-G2	B2-U0-G3	B3-U0-G4	B3-U0-G4	B3-U0-G4	B3-U0-G5	B3-U0-G5	B4-U0-G5
	Lumens per Watt	132	140	141	138	140	140	139	142	143
<b>T2R</b>	4000K Lumens	5,868	11,662	17,311	22,941	29,041	34,388	40,391	46,827	52,572
	BUG Rating	B1-U0-G1	B2-U0-G2	B2-U0-G2	B3-U0-G3	B3-U0-G3	B3-U0-G4	B3-U0-G4	B3-U0-G4	B3-U0-G5
	Lumens per Watt	133	142	143	140	142	142	141	144	144
<b>T3</b>	4000K Lumens	5,710	11,347	16,845	22,322	28,258	33,461	39,303	45,565	51,155
	BUG Rating	B1-U0-G1	B2-U0-G2	B3-U0-G3	B3-U0-G3	B3-U0-G4	B3-U0-G4	B4-U0-G4	B4-U0-G5	B4-U0-G5
	Lumens per Watt	130	138	139	136	139	138	137	140	141
<b>T3R</b>	4000K Lumens	5,892	11,710	17,383	23,035	29,161	34,530	40,558	47,020	52,788
	BUG Rating	B1-U0-G2	B2-U0-G2	B2-U0-G3	B3-U0-G4	B3-U0-G4	B3-U0-G5	B3-U0-G5	B3-U0-G5	B4-U0-G5
	Lumens per Watt	134	143	144	140	143	142	142	145	145
<b>T4FT</b>	4000K Lumens	5,745	11,418	16,949	22,460	28,433	33,668	39,546	45,847	51,471
	BUG Rating	B1-U0-G2	B2-U0-G3	B2-U0-G3	B3-U0-G4	B3-U0-G4	B3-U0-G5	B3-U0-G5	B4-U0-G5	B4-U0-G5
	Lumens per Watt	131	139	140	137	139	139	138	141	141
<b>T4W</b>	4000K Lumens	5,762	11,451	16,999	22,526	28,517	33,767	39,662	45,982	51,622
	BUG Rating	B1-U0-G2	B2-U0-G2	B3-U0-G3	B3-U0-G4	B3-U0-G4	B3-U0-G5	B4-U0-G5	B4-U0-G5	B4-U0-G5
	Lumens per Watt	131	140	140	137	140	139	139	141	142
<b>SL2</b>	4000K Lumens	5,747	11,422	16,956	22,469	28,444	33,681	39,561	45,865	51,491
	BUG Rating	B1-U0-G2	B2-U0-G3	B3-U0-G3	B3-U0-G4	B3-U0-G4	B3-U0-G4	B4-U0-G5	B4-U0-G5	B4-U0-G5
	Lumens per Watt	131	139	140	137	139	139	138	141	141
<b>SL3</b>	4000K Lumens	5,707	11,342	16,836	22,311	28,244	33,444	39,283	45,542	51,129
	BUG Rating	B1-U0-G2	B2-U0-G3	B2-U0-G3	B3-U0-G4	B3-U0-G4	B3-U0-G5	B3-U0-G5	B3-U0-G5	B3-U0-G5
	Lumens per Watt	130	138	139	136	138	138	137	140	140
<b>SL4</b>	4000K Lumens	5,636	11,201	16,627	22,034	27,893	33,028	38,794	44,976	50,493
	BUG Rating	B1-U0-G2	B1-U0-G3	B2-U0-G4	B2-U0-G4	B3-U0-G5	B3-U0-G5	B3-U0-G5	B3-U0-G5	B3-U0-G5
	Lumens per Watt	128	137	137	134	137	136	136	138	139
<b>5NQ</b>	4000K Lumens	6,009	11,942	17,727	23,492	29,739	35,214	41,362	47,953	53,835
	BUG Rating	B2-U0-G1	B3-U0-G1	B4-U0-G2	B4-U0-G2	B5-U0-G2	B5-U0-G2	B5-U0-G3	B5-U0-G3	B5-U0-G3
	Lumens per Watt	137	146	147	143	146	145	145	148	148
<b>5MQ</b>	4000K Lumens	6,039	12,001	17,816	23,609	29,887	35,389	41,568	48,191	54,103
	BUG Rating	B3-U0-G1	B4-U0-G2	B4-U0-G2	B5-U0-G3	B5-U0-G3	B5-U0-G4	B5-U0-G4	B5-U0-G4	B5-U0-G5
	Lumens per Watt	137	146	147	144	147	146	145	148	149
<b>5WQ</b>	4000K Lumens	6,026	11,976	17,778	23,559	29,824	35,315	41,480	48,090	53,989
	BUG Rating	B3-U0-G1	B4-U0-G2	B5-U0-G3	B5-U0-G3	B5-U0-G4	B5-U0-G4	B5-U0-G4	B5-U0-G5	B5-U0-G5
	Lumens per Watt	137	146	147	144	146	145	145	148	148
<b>SLL/SLR</b>	4000K Lumens	4,963	9,863	14,642	19,403	24,563	29,085	34,163	39,607	44,465
	BUG Rating	B1-U0-G2	B1-U0-G3	B2-U0-G3	B2-U0-G4	B3-U0-G4	B3-U0-G5	B3-U0-G5	B3-U0-G5	B3-U0-G5
	Lumens per Watt	113	120	121	118	120	120	119	122	122
<b>RW</b>	4000K Lumens	5,940	11,806	17,526	23,224	29,400	34,813	40,891	47,407	53,222
	BUG Rating	B3-U0-G1	B3-U0-G2	B4-U0-G2	B4-U0-G2	B5-U0-G3	B5-U0-G3	B5-U0-G3	B5-U0-G4	B5-U0-G4
	Lumens per Watt	135	144	145	142	144	143	143	146	146
<b>AFL</b>	4000K Lumens	5,814	11,555	17,153	22,730	28,775	34,073	40,021	46,398	52,090
	BUG Rating	B1-U0-G1	B2-U0-G1	B2-U0-G2	B2-U0-G2	B3-U0-G3	B3-U0-G3	B3-U0-G3	B3-U0-G3	B3-U0-G4
	Lumens per Watt	132	141	142	139	141	140	140	143	143

\* Nominal data for 70 CRI. \*\* For additional performance data, please reference the Galleon Supplemental Performance Guide.



Performance Table, Drive Current "C" (1050mA)

Number of Light Squares		1	2	3	4	5	6	7	8	9
<b>Nominal Power (Watts)</b>		57	108	160	213	269	321	377	429	481
<b>Input Current @ 120V</b>		0.478	0.905	1.338	1.810	2.244	2.675	3.150	3.584	4.013
<b>Input Current @ 208V</b>		0.279	0.532	0.780	1.064	1.313	1.559	1.845	2.093	2.339
<b>Input Current @ 240V</b>		0.243	0.458	0.664	0.916	1.123	1.328	1.582	1.788	1.991
<b>Input Current @ 277V</b>		0.213	0.404	0.582	0.808	0.997	1.164	1.401	1.589	1.745
<b>Input Current @ 347V</b>		0.164	0.322	0.471	0.644	0.795	0.943	1.117	1.269	1.414
<b>Input Current @ 480V</b>		0.121	0.235	0.341	0.469	0.579	0.681	0.814	0.923	1.022
Optics										
<b>T2</b>	4000K Lumens	7,154	14,219	21,107	27,970	35,408	41,927	49,247	57,094	64,098
	BUG Rating	B1-U0-G2	B2-U0-G2	B3-U0-G3	B3-U0-G4	B3-U0-G4	B3-U0-G5	B4-U0-G5	B4-U0-G5	B4-U0-G5
	Lumens per Watt	126	132	132	131	132	131	131	133	133
<b>T2R</b>	4000K Lumens	7,250	14,408	21,389	28,344	35,881	42,487	49,905	57,857	64,954
	BUG Rating	B1-U0-G1	B2-U0-G2	B2-U0-G3	B3-U0-G3	B3-U0-G4	B3-U0-G4	B3-U0-G5	B4-U0-G5	B4-U0-G5
	Lumens per Watt	127	133	134	133	133	132	132	135	135
<b>T3</b>	4000K Lumens	7,054	14,020	20,812	27,580	34,914	41,342	48,560	56,297	63,203
	BUG Rating	B1-U0-G2	B2-U0-G2	B3-U0-G3	B3-U0-G4	B3-U0-G4	B4-U0-G4	B4-U0-G5	B4-U0-G5	B4-U0-G5
	Lumens per Watt	124	130	130	129	130	129	129	131	131
<b>T3R</b>	4000K Lumens	7,280	14,468	21,477	28,461	36,029	42,663	50,111	58,096	65,222
	BUG Rating	B1-U0-G2	B2-U0-G3	B3-U0-G4	B3-U0-G4	B3-U0-G5	B3-U0-G5	B3-U0-G5	B4-U0-G5	B4-U0-G5
	Lumens per Watt	128	134	134	134	134	133	133	135	136
<b>T4FT</b>	4000K Lumens	7,098	14,107	20,941	27,751	35,130	41,598	48,860	56,646	63,594
	BUG Rating	B1-U0-G2	B2-U0-G3	B3-U0-G4	B3-U0-G4	B3-U0-G5	B3-U0-G5	B4-U0-G5	B4-U0-G5	B4-U0-G5
	Lumens per Watt	125	131	131	130	131	130	130	132	132
<b>T4W</b>	4000K Lumens	7,119	14,148	21,003	27,832	35,233	41,720	49,004	56,812	63,781
	BUG Rating	B1-U0-G2	B2-U0-G3	B3-U0-G4	B3-U0-G4	B3-U0-G5	B4-U0-G5	B4-U0-G5	B4-U0-G5	B4-U0-G5
	Lumens per Watt	125	131	131	131	131	130	130	132	133
<b>SL2</b>	4000K Lumens	7,101	14,112	20,949	27,761	35,144	41,614	48,879	56,668	63,619
	BUG Rating	B1-U0-G2	B2-U0-G3	B3-U0-G3	B3-U0-G4	B3-U0-G5	B4-U0-G5	B4-U0-G5	B4-U0-G5	B4-U0-G5
	Lumens per Watt	125	131	131	130	131	130	130	132	132
<b>SL3</b>	4000K Lumens	7,051	14,013	20,802	27,566	34,897	41,321	48,535	56,269	63,172
	BUG Rating	B1-U0-G2	B2-U0-G3	B2-U0-G4	B3-U0-G4	B3-U0-G5	B3-U0-G5	B3-U0-G5	B4-U0-G5	B4-U0-G5
	Lumens per Watt	124	130	130	129	130	129	129	131	131
<b>SL4</b>	4000K Lumens	6,963	13,839	20,543	27,223	34,463	40,808	47,932	55,569	62,386
	BUG Rating	B1-U0-G2	B2-U0-G3	B2-U0-G4	B3-U0-G5	B3-U0-G5	B3-U0-G5	B3-U0-G5	B3-U0-G5	B3-U0-G5
	Lumens per Watt	122	128	128	128	128	127	127	130	130
<b>5NQ</b>	4000K Lumens	7,424	14,755	21,903	29,025	36,743	43,508	51,104	59,247	66,515
	BUG Rating	B3-U0-G1	B3-U0-G2	B4-U0-G2	B5-U0-G2	B5-U0-G3	B5-U0-G3	B5-U0-G3	B5-U0-G3	B5-U0-G4
	Lumens per Watt	130	137	137	136	137	136	136	138	138
<b>5MQ</b>	4000K Lumens	7,461	14,828	22,012	29,169	36,926	43,725	51,359	59,542	66,846
	BUG Rating	B3-U0-G1	B4-U0-G2	B5-U0-G3	B5-U0-G3	B5-U0-G4	B5-U0-G4	B5-U0-G4	B5-U0-G5	B5-U0-G5
	Lumens per Watt	131	137	138	137	137	136	136	139	139
<b>5WQ</b>	4000K Lumens	7,445	14,797	21,966	29,108	36,849	43,633	51,250	59,417	66,705
	BUG Rating	B3-U0-G2	B4-U0-G2	B5-U0-G3	B5-U0-G4	B5-U0-G4	B5-U0-G5	B5-U0-G5	B5-U0-G5	B5-U0-G5
	Lumens per Watt	131	137	137	137	137	136	136	139	139
<b>SLL/SLR</b>	4000K Lumens	6,132	12,187	18,091	23,973	30,348	35,936	42,210	48,935	54,938
	BUG Rating	B1-U0-G2	B2-U0-G3	B2-U0-G3	B3-U0-G4	B3-U0-G5	B3-U0-G5	B3-U0-G5	B3-U0-G5	B3-U0-G5
	Lumens per Watt	108	113	113	113	113	112	112	114	114
<b>RW</b>	4000K Lumens	7,340	14,587	21,653	28,694	36,325	43,013	50,522	58,573	65,757
	BUG Rating	B3-U0-G1	B3-U0-G2	B4-U0-G2	B4-U0-G2	B5-U0-G3	B5-U0-G3	B5-U0-G4	B5-U0-G4	B5-U0-G4
	Lumens per Watt	129	135	135	135	135	134	134	137	137
<b>AFL</b>	4000K Lumens	7,183	14,276	21,193	28,084	35,552	42,098	49,448	57,327	64,359
	BUG Rating	B1-U0-G1	B2-U0-G2	B2-U0-G2	B3-U0-G2	B3-U0-G3	B3-U0-G3	B3-U0-G4	B3-U0-G4	B4-U0-G4
	Lumens per Watt	126	132	132	132	132	131	131	134	134

\* Nominal data for 70 CRI. \*\* For additional performance data, please reference the Galleon Supplemental Performance Guide.

**Performance Table, Drive Current "D" (1200mA)**

Number of Light Squares		1	2	3	4	5	6	7	8	9
<b>Nominal Power (Watts)</b>		65	125	184	245	309	368	433	493	552
<b>Input Current @ 120V</b>		0.546	1.041	1.535	2.082	2.578	3.070	3.619	4.114	4.605
<b>Input Current @ 208V</b>		0.318	0.610	0.893	1.219	1.504	1.786	2.113	2.397	2.679
<b>Input Current @ 240V</b>		0.276	0.523	0.758	1.046	1.282	1.516	1.806	2.041	2.274
<b>Input Current @ 277V</b>		0.241	0.460	0.662	0.920	1.133	1.325	1.593	1.807	1.987
<b>Input Current @ 347V</b>		0.187	0.370	0.543	0.740	0.915	1.085	1.285	1.459	1.628
<b>Input Current @ 480V</b>		0.138	0.269	0.391	0.537	0.663	0.782	0.932	1.057	1.173
Optics										
<b>T2</b>	4000K Lumens	7,872	15,645	23,225	30,777	38,962	46,135	54,189	62,824	70,530
	BUG Rating	B1-U0-G2	B2-U0-G3	B3-U0-G4	B3-U0-G4	B3-U0-G5	B3-U0-G5	B4-U0-G5	B4-U0-G5	B4-U0-G5
	Lumens per Watt	121	125	126	126	126	125	125	127	128
<b>T2R</b>	4000K Lumens	7,977	15,854	23,535	31,188	39,482	46,751	54,913	63,663	71,472
	BUG Rating	B1-U0-G2	B2-U0-G2	B3-U0-G3	B3-U0-G4	B3-U0-G4	B3-U0-G4	B4-U0-G5	B4-U0-G5	B4-U0-G5
	Lumens per Watt	123	127	128	127	128	127	127	129	129
<b>T3</b>	4000K Lumens	7,762	15,427	22,901	30,348	38,418	45,491	53,433	61,947	69,546
	BUG Rating	B2-U0-G2	B3-U0-G3	B3-U0-G3	B3-U0-G4	B4-U0-G4	B4-U0-G5	B4-U0-G5	B4-U0-G5	B4-U0-G5
	Lumens per Watt	119	123	124	124	124	124	123	126	126
<b>T3R</b>	4000K Lumens	8,010	15,920	23,632	31,317	39,645	46,944	55,139	63,925	71,767
	BUG Rating	B1-U0-G2	B2-U0-G3	B3-U0-G4	B3-U0-G4	B3-U0-G5	B3-U0-G5	B4-U0-G5	B4-U0-G5	B4-U0-G5
	Lumens per Watt	123	127	128	128	128	128	127	130	130
<b>T4FT</b>	4000K Lumens	7,810	15,522	23,043	30,535	38,655	45,772	53,763	62,330	69,976
	BUG Rating	B1-U0-G2	B2-U0-G3	B3-U0-G4	B3-U0-G4	B3-U0-G5	B4-U0-G5	B4-U0-G5	B4-U0-G5	B4-U0-G5
	Lumens per Watt	120	124	125	125	125	124	124	126	127
<b>T4W</b>	4000K Lumens	7,833	15,568	23,110	30,625	38,769	45,907	53,921	62,513	70,182
	BUG Rating	B2-U0-G2	B3-U0-G3	B3-U0-G4	B3-U0-G5	B4-U0-G5	B4-U0-G5	B4-U0-G5	B4-U0-G5	B4-U0-G5
	Lumens per Watt	121	125	126	125	125	125	125	127	127
<b>SL2</b>	4000K Lumens	7,813	15,528	23,052	30,547	38,670	45,790	53,784	62,354	70,003
	BUG Rating	B2-U0-G2	B3-U0-G3	B3-U0-G4	B3-U0-G4	B4-U0-G5	B4-U0-G5	B4-U0-G5	B4-U0-G5	B4-U0-G5
	Lumens per Watt	120	124	125	125	125	124	124	126	127
<b>SL3</b>	4000K Lumens	7,758	15,419	22,889	30,332	38,398	45,468	53,406	61,916	69,511
	BUG Rating	B1-U0-G2	B2-U0-G3	B3-U0-G4	B3-U0-G4	B3-U0-G5	B3-U0-G5	B3-U0-G5	B4-U0-G5	B4-U0-G5
	Lumens per Watt	119	123	124	124	124	124	123	126	126
<b>SL4</b>	4000K Lumens	7,662	15,228	22,605	29,955	37,921	44,903	52,742	61,146	68,646
	BUG Rating	B1-U0-G3	B2-U0-G3	B2-U0-G4	B3-U0-G5	B3-U0-G5	B3-U0-G5	B3-U0-G5	B3-U0-G5	B4-U0-G5
	Lumens per Watt	118	122	123	122	123	122	122	124	124
<b>5NQ</b>	4000K Lumens	8,169	16,235	24,101	31,938	40,431	47,874	56,232	65,193	73,190
	BUG Rating	B3-U0-G1	B3-U0-G2	B4-U0-G2	B5-U0-G2	B5-U0-G3	B5-U0-G3	B5-U0-G4	B5-U0-G4	B5-U0-G4
	Lumens per Watt	126	130	131	130	131	130	130	132	133
<b>5MQ</b>	4000K Lumens	8,210	16,316	24,221	32,097	40,632	48,113	56,512	65,517	73,554
	BUG Rating	B3-U0-G2	B4-U0-G2	B5-U0-G3	B5-U0-G3	B5-U0-G4	B5-U0-G4	B5-U0-G5	B5-U0-G5	B5-U0-G5
	Lumens per Watt	126	131	132	131	131	131	131	133	133
<b>5WQ</b>	4000K Lumens	8,192	16,282	24,170	32,029	40,546	48,011	56,393	65,379	73,399
	BUG Rating	B3-U0-G2	B4-U0-G2	B5-U0-G3	B5-U0-G4	B5-U0-G4	B5-U0-G5	B5-U0-G5	B5-U0-G5	B5-U0-G5
	Lumens per Watt	126	130	131	131	131	130	130	133	133
<b>SLL/SLR</b>	4000K Lumens	6,747	13,410	19,906	26,379	33,394	39,542	46,445	53,846	60,451
	BUG Rating	B1-U0-G2	B2-U0-G3	B2-U0-G4	B3-U0-G4	B3-U0-G5	B3-U0-G5	B3-U0-G5	B3-U0-G5	B4-U0-G5
	Lumens per Watt	104	107	108	108	108	107	107	109	110
<b>RW</b>	4000K Lumens	8,076	16,050	23,826	31,574	39,970	47,329	55,592	64,450	72,356
	BUG Rating	B3-U0-G1	B4-U0-G2	B4-U0-G2	B5-U0-G3	B5-U0-G3	B5-U0-G4	B5-U0-G4	B5-U0-G4	B5-U0-G5
	Lumens per Watt	124	128	129	129	129	129	128	131	131
<b>AFL</b>	4000K Lumens	7,904	15,709	23,320	30,902	39,120	46,323	54,410	63,079	70,817
	BUG Rating	B1-U0-G1	B2-U0-G2	B3-U0-G2	B3-U0-G3	B3-U0-G3	B3-U0-G3	B3-U0-G4	B4-U0-G4	B4-U0-G4
	Lumens per Watt	122	126	127	126	127	126	126	128	128

\* Nominal data for 70 CRI. \*\* For additional performance data, please reference the Galleon Supplemental Performance Guide.

## Control Options

### 0-10V (DIM)

This fixture is offered standard with 0-10V dimming driver(s). The DIM option provides 0-10V dimming wire leads for use with a lighting control panel or other control method.

### Photocontrol (BPC, PR and PR7)

Optional button-type photocontrol (BPC) and photocontrol receptacles (PR and PR7) provide a flexible solution to enable "dusk-to-dawn" lighting by sensing light levels. Advanced control systems compatible with NEMA 7-pin standards can be utilized with the PR7 receptacle.

### After Hours Dim (AHD)

This feature allows photocontrol-enabled luminaires to achieve additional energy savings by dimming during scheduled portions of the night. The dimming profile will automatically take effect after a "dusk-to-dawn" period has been calculated from the photocontrol input. Specify the desired dimming profile for a simple, factory-shipped dimming solution requiring no external control wiring. Reference the After Hours Dim supplemental guide for additional information.

### Dimming Occupancy Sensor (SPB)

These passive infrared (PIR) sensors are factory installed in the luminaire housing. When the SPB sensor option is selected, the occupancy sensor is connected to a dimming driver and the entire luminaire dims when no motion is detected. After a period of time, the luminaire turns off, and when motion is detected, the luminaire returns to full light output. The SPB sensor default parameters are listed in the table below, and can be configured utilizing the Sensor Configuration mobile application for iOS and Android devices. The SPB/X is configured to control only the specified number of light squares. An integral photocontrol can be activated with the app for "dusk-to-dawn" control or daylight harvesting - the factory default is off. Three sensor lenses are available to optimize the coverage pattern for mounting heights from 8'-40'. Four sensor colors are available; Bronze, Black, Gray and White, and are automatically selected based on the luminaire finish as indicated by the table below.

SPB sensor finish matched to luminaire finish		
Luminaire Finish		SPB Sensor Finish
WH	White	White
BK	Black	Black
GM	Graphite Metallic	Black
BZ	Bronze	Bronze
AP	Gray	Gray
DP	Dark Platinum	Gray

SPB/X Availability Table	
Fixture Square Count	Available SPB/X Square Count
1	Not Available
2	Not Available
3	Not Available
4	2
5	2 or 3
6	3
7	2, 3, 4 or 5
8	2, 3, 5 or 6
9	3 or 6

### WaveLinx Wireless Control and Monitoring System

Operates on a wireless mesh network based on IEEE 802.15.4 standards enabling wireless control of outdoor lighting. WaveLinx and WaveLinx Lite sensors utilize the Zhaga Book 18 compliant 4-PIN receptacle (ZD or ZW), while the WOLC control module utilizes a 7-PIN receptacle. ZW option provides 4-PIN receptacle and control module to enable future installation of WaveLinx sensors. ZD option provides 4-PIN receptacle and sensor-ready (SR) driver to enable future installation of WaveLinx sensors, power monitoring, and advanced functionality. WaveLinx (SWPD4 to SWPD5) outdoor wireless sensors offer passive infrared (PIR) occupancy and photocell for closed loop daylight harvesting, and can be factory or field-installed. Sensors are factory preset to dim down to 50% after 15 minutes of no motion detected. Two lens options are available for mounting heights of 7' to 40'. Use the WaveLinx mobile application for set-up and configuration. At least one Wireless Area Controller (WAC) is required for full functionality and remote communication (including adjustment of any factory pre-sets). WaveLinx Lite (WOF and WOB) outdoor wireless sensors provide PIR occupancy and photocell for closed loop daylight harvesting, and can be factory or field-installed. Sensors are factory preset to dim down to 50% after 15 minutes of no motion detected. Two lens options are available for mounting heights of 7' to 40'. Use the WaveLinx Lite mobile application for set-up and configuration. WAC not required. WaveLinx Outdoor Control Module (WOLC-7P-10A) accessory provides a photocontrol enabling astronomic or time-based schedules to provide ON, OFF and dimming control of fixtures utilizing a 7-PIN receptacle. The out-of-box functionality is ON at dusk and OFF at dawn.

#### For mounting heights up to 15' (SWPD4 and WOB)

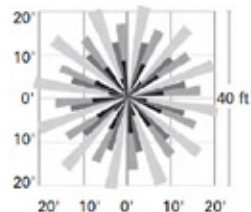
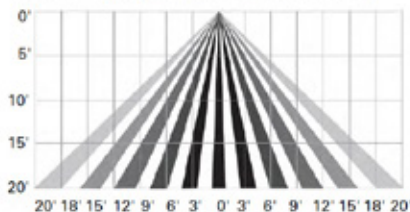

#### For mounting heights up to 40' (SWPD5 and WOF)

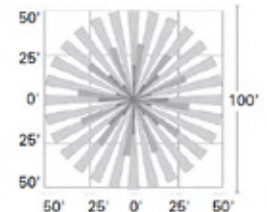
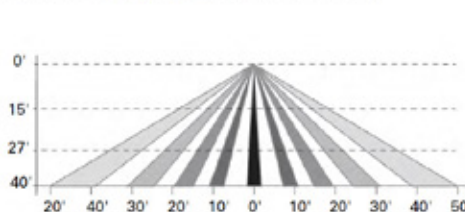

### LumenSafe Integrated Network Security Camera (LD)

Cooper Lighting Solutions brings ease of camera deployment to a whole new level. No additional wiring is needed beyond providing line power to the luminaire. A variety of networking options allows security integrators to design the optimal solution for active surveillance. As the ideal solution to meet the needs for active surveillance, the LumenSafe integrated network camera is a streamlined, outdoor-ready fixed dome that provides HDTV 1080p video. This IP camera is optimally designed for deployment in the video management system or security software platform of choice.

### Synapse (DIM10)

SimplySNAP integrated wireless controls system by Synapse. Includes factory installed DIM10 Synapse control module and FSP-201 motion sensor; requires additional Synapse system components for operation. Contact Synapse at [www.synapsewireless.com](http://www.synapsewireless.com) for product support, warranty and terms and conditions.